

Perkins Power Products, LLC

WE SUPPLY COMPONENTS:

HELWIG CARBON PRODUCTS

MAGNETEK BY COLUMBUS MCKINNON

POWEROHM BY HUBBELL ICD

DELTA STAR BY TRANSTECH INC

DONALDSON TORIT

SPANGUARD

PHOENIX ELECTRIC

ELEC-TRON

SABLE PLASTICS GROUP

MARTINDALE ELECTRIC COMPANY

VAHLE INC.

PERKINS RESOURCE FOR HARD-TO-FIND  
ELECTRICAL & MECHANICAL PARTS

Service with a Sense of Humor



# SERVICES

## Helwig Carbon Products Inc.

- Plant Surveys
- Inventory Control & Consolidation
- Shaft Grounding Testing
- Onsite Trouble Shooting
- Virtual Application Reviews
- Training



A good ground is a regularly tested ground.



BPK Probe kit includes oscilloscope



BPK Remote Kit records events over time



# SOLUTIONS

Helwig Carbon Products Inc.

- Brush holders - design and engineering
- Carbon brushes
- Springs - constant pressure and non-constant pressure
- Brush Wear Indicators
- Mechanical carbons
- Collector Shoes & Sliding Contacts

## CONSTANT FORCE SPRING ADVANTAGES



■ Enhances Brush Life and Performance

## FAMILY OF PRODUCTS

### Motor/Generator Brushes

- Carbon Graphite
- Graphite
- Electrographite
- Copper Graphite
- Silver Graphite
- Molded



### Brush Holders

- Industrial, Slip-Ring, Turbine, Multiple Box
- Cast (High Volume) or Machined
- Springs Assemblies
- Brush Wear Indicators
- Helwig Quick Disconnects



### Shaft Grounding System

- Bearing Protection Kits™
- BPK-Probe™
- MultiFit Brackets



### Carbon Graphite Components

- Vanes & Rotors
- Seals, Rings, & Steam Joints
- Bearings & Bushings



### Collector Shoes & Sliding Contacts



# DC/AC MOTOR ACCESSORIES

## Helwig Carbon Products Inc.

- Tachometers & Encoders
- Crane Duty Blowers
- Encode & Tachometer/Encoder Package
- Tachometer & Encoder Mounting Kits
- Blower Wheels
- Couplings
- Cooling Blower Failure Switches
- Mounting Plates & Blank Cover Plates
- Transition Adapter Bases
- Belly Bands
- Tach/Encoder Stubs

Helwig Carbon Products, Inc.  
8900 West Tower Avenue  
Milwaukee, WI 53224  
800-962-4851 or 414-354-2411  
Email: [carboncrew@helwigcarbon.com](mailto:carboncrew@helwigcarbon.com) (US)  
[intl@helwigcarbon.com](mailto:intl@helwigcarbon.com) (International Orders)  
Website: [helwigcarbon.com](http://helwigcarbon.com)

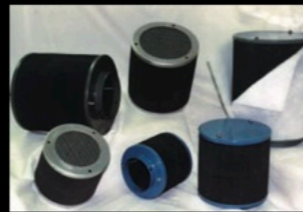

- DC or AC Motor Blowers
- PY Tachometer Mounting Kits
- Encoder Mounting Kits
- Heavy Duty Dancer Housings
- Filters - Standard and Special
- Special Blowers and Accessories

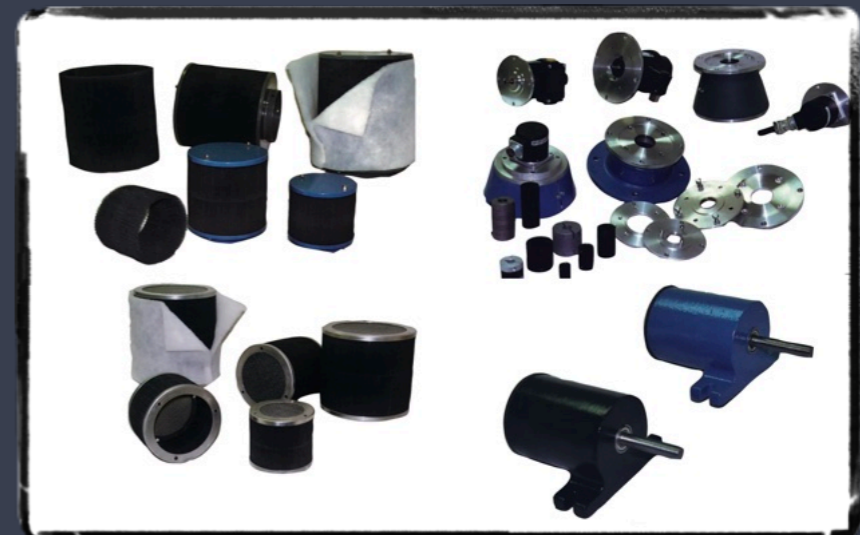

Heavy duty cooling blowers, cooling blower filters, replacement filters, heavy duty dancer potentiometers

[perkinspowerproducts.com](http://perkinspowerproducts.com)





# MAGNETEK

For more than 30 years, Magnetek has served the needs of both traditional and emerging commercial markets that are increasingly dependent on “smart” power. They understand their customers’ needs and apply their knowledge of digital power and motion control to enhance their success.

As America's largest supplier of digital drive systems for crane and hoist applications, they are also dedicated to energy efficiency. Magnetek Energy Engineered® products include radio remote controls, braking and collision avoidance subsystems and motors for industrial cranes and hoists.

From crane controls to power delivery systems, Magnetek products represent quality and innovation in motion control technology.

**We serve Washington, Oregon, Idaho,  
Montana, and Alaska.**

A variety of radio systems to meet your application’s needs.



## Impulse G+ and VG+ Drives

### Series 4



Series 4 available through end of 2024

### Series 5



Smaller footprint, deeper chassis

1. A few of the specialty firmware features will now be included in the S5 drive that they currently charge extra for in the S4 drive.
  - Sway control feature will be included in the S5 drive as a standard.
  - Static Stepless Simulation feature will be included in the S5 drive as a standard.
  - Weight Measurement/Load Summation feature will be included in the S5 drive as a standard.
  - Hoist Synchronization and Bucket firmware's will remain as separate firmware versions for an additional fee.
2. They are including the control intelligence of their Laserguard 2 collision avoidance system into the firmware of the S5 drive. This will allow you to input the laser heads directly into the drive without the need for the additional controller.
3. Internal braking transistors are not included up through 100hp (460v)
4. An on board built in 24vdc power supply that can be used for maintaining the control board alive with main power down. This will keep your communication logic alive to eliminate boot up time and allow for programming with main power down.
5. Keypad display will be clearer and allow more characters.
6. Smaller panel footprint (height and width) but depth may be slightly deeper in some sizes.
7. They eliminated the internal memory on the interface card making for easier plug and play replacements. (Fixes the mated chipset issue)
8. Safe Torque Off circuit is now SIL3 rated.
9. There will be a new multi-protocol communication card offered that will combine Ethernet, Modbus TCP, and Profinet in one card.





## Automated Crane Systems



## AC Pre-engineered Panels



## AC Engineered Panels



## AC Regenerative Drives

### Impulse R+



### Impulse D+



Impulse D+ HHP is a modular, regenerative inverter platform

Magnetek's automated crane systems allow you to build safety right into equipment while also providing real-time data and information that enables you to improve operational efficiency and make smarter decisions faster. Improve safety, streamline operations, increase process efficiency, better plan for maintenance, predict equipment failures, and effectively monitor equipment within your facility.

Magnetek® AC crane control panels are available in pre-engineered and custom configurations. Their overhead crane control panels feature all the components needed to provide full control for any project - from the simple to the complex. Browse through our easy-to-install pre-engineered and custom AC control panel options outfitted with Magnetek IMPULSE® variable frequency drives (VFDs).

Magnetek's high performance AC Line Regenerative Systems are ideal for adjustable speed applications that include a high demand braking cycle. These industrial grade units take surplus regenerative energy from the motor and return it to the AC power source, reducing total energy consumption and improving energy efficiency.





# MAGNETEK

Magnetek, Inc.  
N49W13650 Campbell Drive  
Menomonee Falls, WI 53051

Main line: 800-288-8178  
Service Department: 866-624-7378

Customer Service Email Portals

Quote requests:  
[mh.salesquotes@magnetek.com](mailto:mh.salesquotes@magnetek.com)

Repair and Technical Service:  
[field.service@magnetek.com](mailto:field.service@magnetek.com)

Purchase order submission:  
[purchase.orders@magnetek.com](mailto:purchase.orders@magnetek.com)

Order Status, Tracking & Invoices:  
[order.status@magnetek.com](mailto:order.status@magnetek.com)



**AC & DC Motor Control Systems**  
AC Drive Support Tools  
Control Panels  
Crane Drives



**AC Line Regenerative Systems**  
Regenerative Drives



**Automation & Diagnostics**  
Intelli-Connect  
Intelli-Crane Automated Crane Systems



**Cable & Festoon Systems**  
Electric Festoon Kits  
Festoon Components

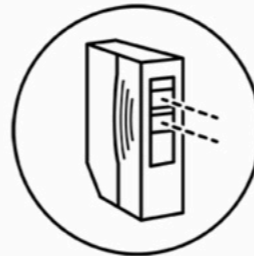

**Collision Avoidance Systems**  
Collision Avoidance Systems

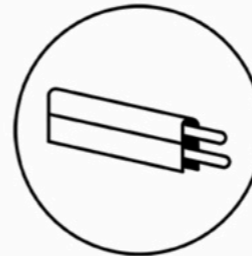

**Conductor Bar Systems**  
Crane Conductor Bar Systems

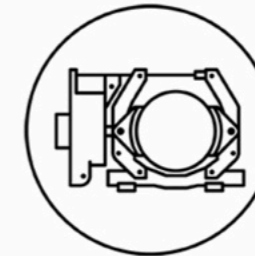

**Crane Brake Products**  
Brake Accessories  
Crane Brake Products

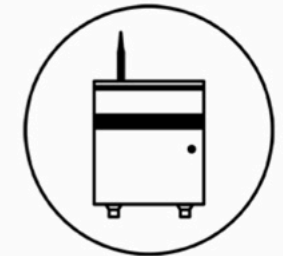

**DC Motor & Magnet Control Systems**  
Custom DC Control Panels  
DC Drive Support Tools  
DC Drives

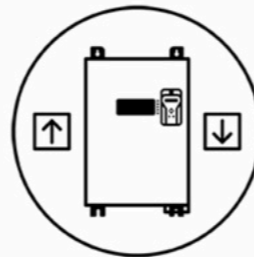

**Elevator and Mining Drives**  
AC Elevator Drives  
DC Elevator Drives



**Industrial Radio Remote Controls**  
Bellybox Transmitters  
Handheld Transmitters  
Options

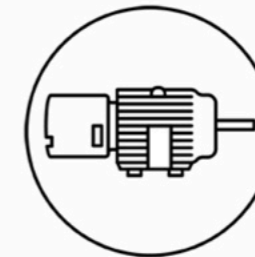

**Inverter Duty Motors**  
Motor Encoders  
Motors

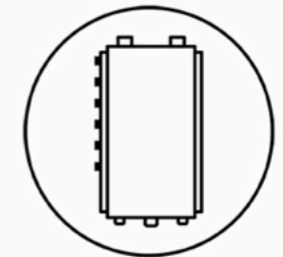

**Mining Drives**  
Custom Power Solutions  
Traction Drives  
Variable Frequency Drives



**Pendant Pushbutton Stations**  
Pendant Pushbutton Stations



**Wind Inverters**  
Wind Inverters

**Link to website:**



# POWEROHM RESISTORS

## a Hubbell Company

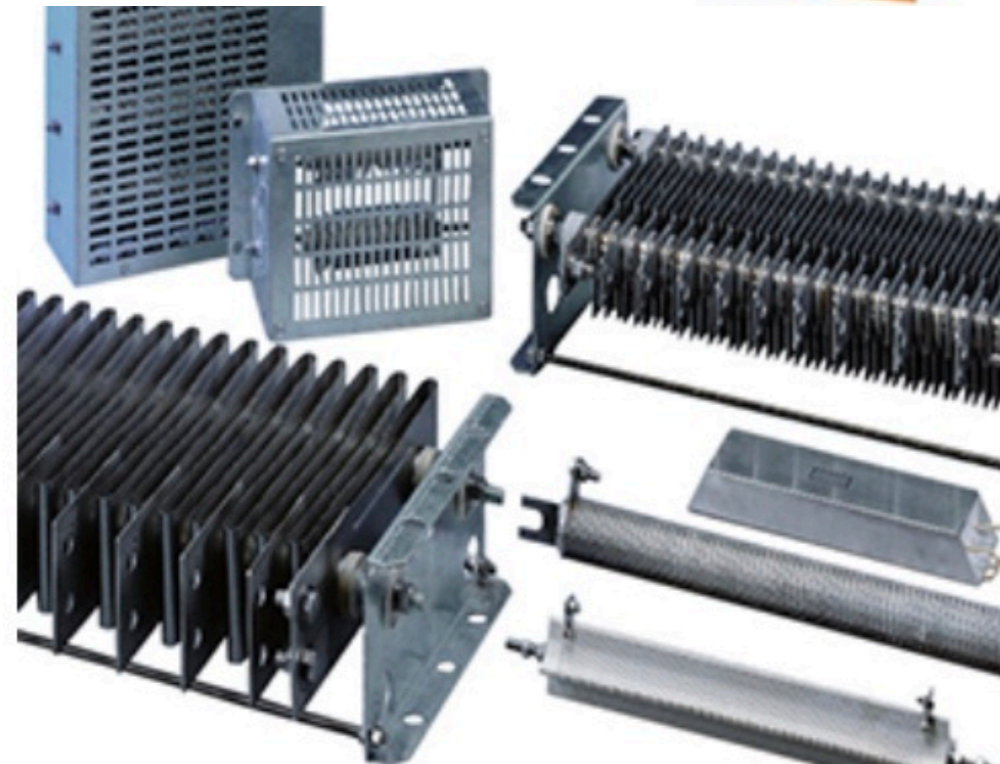

**We serve Washington, Idaho, Montana and Alaska**

Powerohm Resistors is an ISO 9001:2015, manufacturer of power resistor products. Powerohm products also feature low inductance resistors, optional all stainless steel construction, and in-house ceramic manufacturing. They offer a broad range of quality power resistor styles. Their diverse selection of resistor products is sure to meet your requirements.

Powerohm Resistors engineering staff has decades of experience in the design and application of power resistors for DC and wound rotor motor control, neutral grounding, load resistors, and harmonic filter resistors -- also dynamic braking resistors and their matching electronic braking choppers to 1200 amps. Products are available with UL/cUL Recognition, UL/cUL Listing, or CSA Certification. Our customer service personnel are knowledgeable and ready to answer your questions.



Powerohm Resistors, a Hubbell Company  
N56W13385 Silver Spring Dr  
Menomonee Falls, WI 53051  
Phone: 800-838-4694 or 859-384-8088

Website: <https://www.hubbell.com/powerohm/en>

Quote requests and Order Entry: [sales@powerohm.com](mailto:sales@powerohm.com)

[perkinpowerproducts.com](http://perkinpowerproducts.com)



We serve Washington, Oregon, and Idaho

# DELTA STAR

Faiveley TransTech,  
a Wabtec Company

- V Bar
- Transductor
- Shoe Type Collectors
- Insulators
- Industrial Pantograph Collectors
- HV Bar
- HJ Bar
- HC Bar
- H Bar
- Cross Arm Collectors
- Contact Members
- C Bar
- Arm Type Collectors

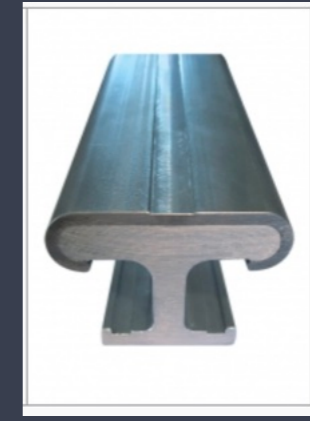
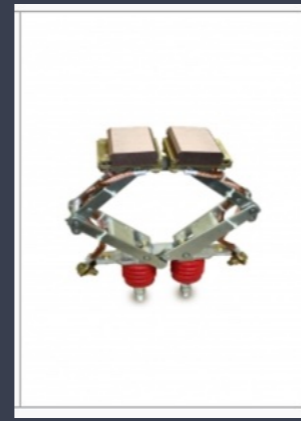
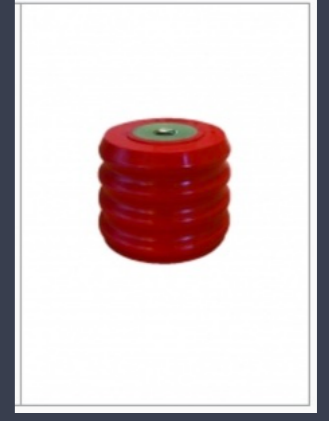

**TransTech**

**46 Beechtree Blvd**

**Greenville, SC 29605**

**800-245-4552 or 864-299-3870**

**Inquiries and Orders: [infotranstech@wabtec.com](mailto:infotranstech@wabtec.com)**

**Website: <https://www.transtech.com/electrification-products/heavy-duty>**

[perkinspowerproducts.com](http://perkinspowerproducts.com)



**We serve Washington, Oregon, Idaho, Montana, Alaska, and British Columbia, Canada**

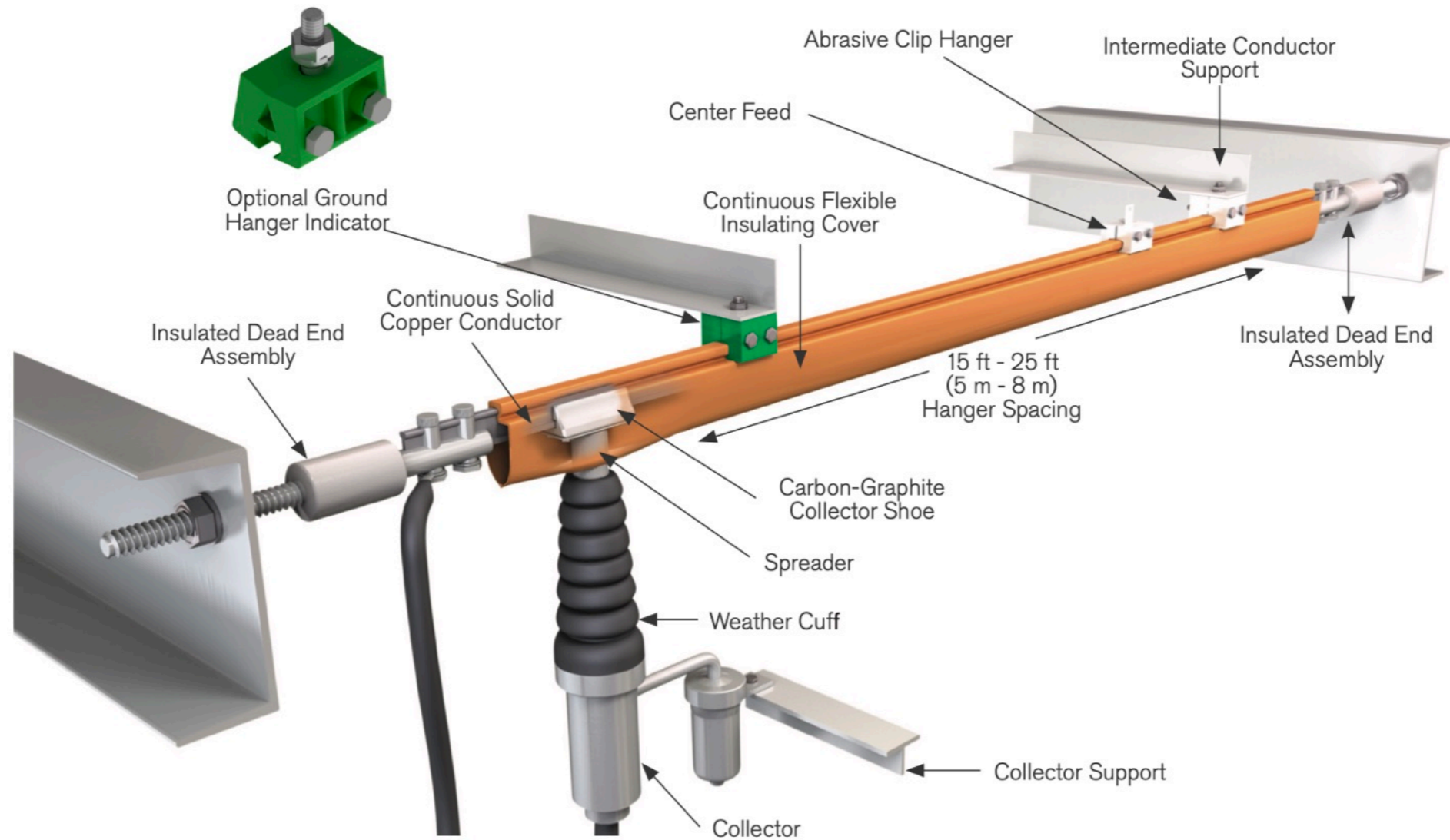

## **U-S Safety Trolley by SpanGuard Corporation**



More than 50 years ago, U-S Safety Trolley engineers recognized electrical joints were the most common source of problems in crane electrification. Today, joints remain the number one cause of maintenance and productivity issues.

U-S Safety Trolley's time-tested, no-joint solutions continue to eliminate issues by providing seamless mobile electrification to the industrial and manufacturing sectors.

Span-Guard Corporation

14 North Main Street

Tioga, PA 16946

Phone: 1-570-948-2627

Quotes and Purchase Orders: [sales@spanguard.net](mailto:sales@spanguard.net)

Website: [spanguard.net](http://spanguard.net)



# Span-Guard Corporation

## The Indoor/Outdoor Industrial Power Supply System for Cranes and Stationary Equipment

- Ampacity: 250 & 520 amps
- Environment: Indoor & Outdoor
- Perfect for: Industrial/ Manufacturing environments, lock & dam installations, crane electrification, steel mills, paper mills
- Special Features: Joint-free with a self-sealing vinyl cover for extra protection

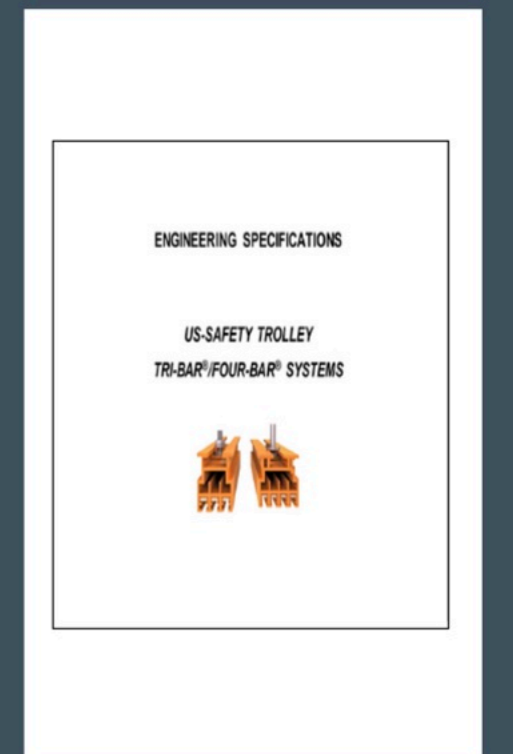
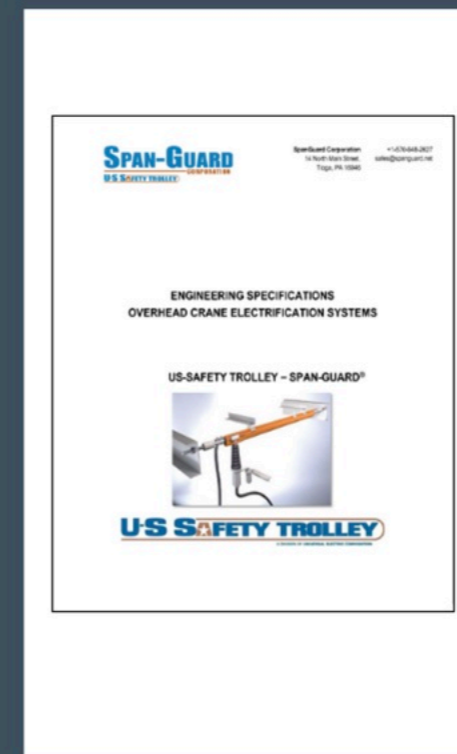
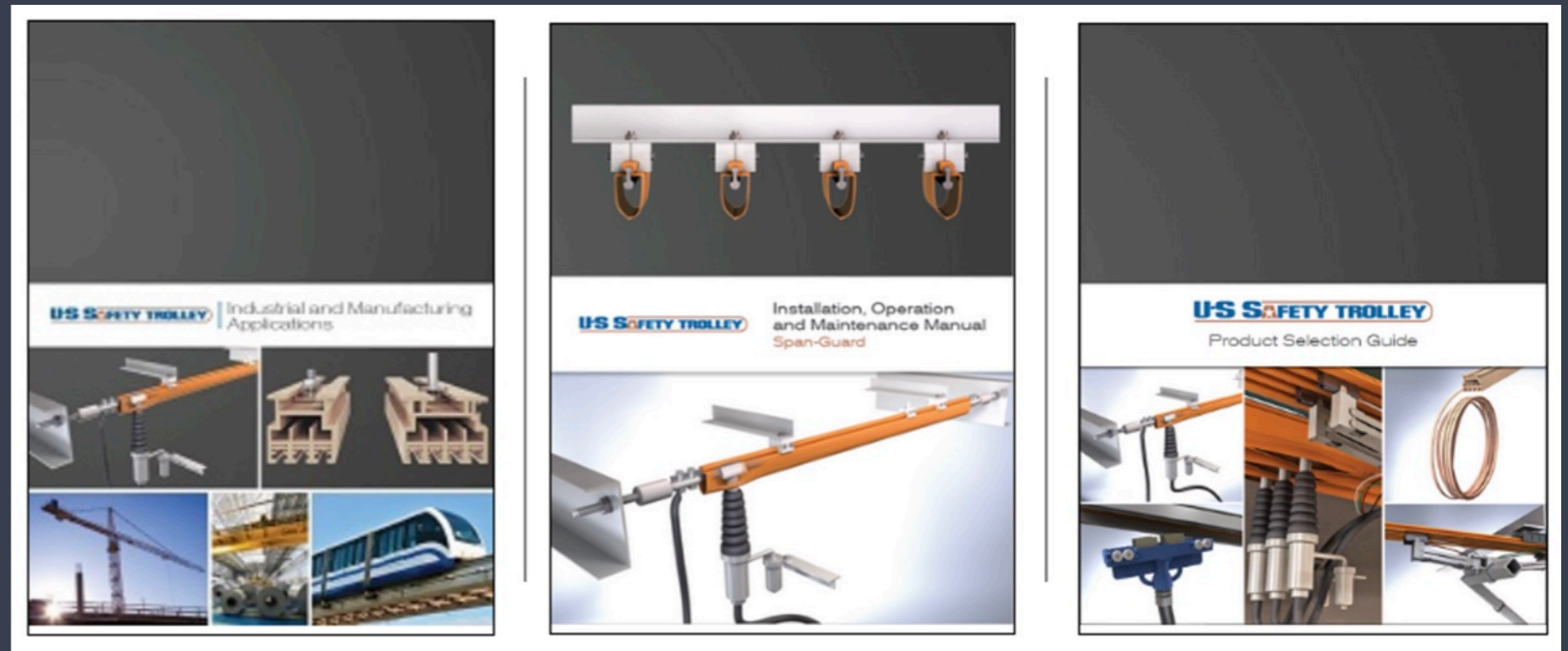

# DONALDSON TORIT

DONALDSON TORIT INDUSTRIAL DUST, FILM & MIST SOLUTIONS

Donaldson Company, Inc, Industrial Air Filtration  
PO Box 1299, Minneapolis MN 55440-1299

**Pacific Northwest Sales office**

Jim Johnson, Northwest Territory Manager

Email: [james.johnson@donaldson.com](mailto:james.johnson@donaldson.com)

Phone: 425-427-8905

Website: [donaldson.com/torit](http://donaldson.com/torit)



***Donaldson Torit Mini-Mist Collector used in power generation application.***

Whether water-soluble coolants, straight oils, or oily smoke, it's important to choose a mist control solution that fits your specific needs. Mist collectors, when properly selected and applied, help maintain a cleaner work environment and reduce maintenance on process machinery in manufacturing facilities. Donaldson Torit's

WSO Mist Collector with its unique Synteq™ XP filter media is an extremely versatile collector for all operations. And our expert consultation helps ensure the proper level of airflow control for the highest levels of productivity and efficiency - for every machining application - with seamless OEM equipment integration.



MM 1200 with Optional Junction Box



The Donaldson Torit® Mini-Mist is designed for CNC machining, grinding, turning, milling and drilling operations. It is used to collect coolant mists such as oil, water-soluble and synthetic coolant mists.

The Mini-Mist design is compact and available in two models; MM 500 for light-duty operations and MM 1200 for machines requiring higher airflow or applications that require a mist and smoke collector.

- Three stage filtration for high filtration efficiency and optimum filter life
- Handles mist, smoke, and particulate applications up to 2,038 m<sup>3</sup>/h / 1200 cfm
- Standard Minihelic® gauge indicates when filter maintenance is required
- Hinged access doors makes filter changeout easy and simple
- Provides a cleaner work environment for maximum productivity
- Helps support OSHA Clean Air Standards
- Optional HEPA filter is available on all models

Model MM 1200 with Optional HEPA



Designed to Filter Contaminants from Machining Operations and Industrial Processes

- CNC machining
- Grinding
- Turning
- Milling
- Drilling operations





# Meet

**PHOENIX**  
The Brush Holder Experts®

**ELEC**  **TRON**  
inc.

 **SABLE PLASTICS GROUP**

We are a group of companies specializing in electrical components for a wide range of industries including HVAC, appliance, electric motors, power tools, automotive, and military applications. While we take great pride in the products that have been the cornerstone of each company for 80 years respectively, we are exploring new applications where we can leverage our knowledge and

experience in plastic injection and compression molding primarily of thermoset but we also can do thermoplastic parts as well. Additionally, we have the capabilities to produce insert molded and assembled solutions. So whether it's a simple plastic part or a complicated plastic and metal assembly, we have the knowledge and experience to meet your needs.

[perkinspowerproducts.com](http://perkinspowerproducts.com)





# PHOENIX ELECTRIC

The experience and expertise of Phoenix Electric allows them to design and manufacturer an infinite variety of brush holders for any application, however unique or demanding. With the wide variety of designs and tooling they have, Phoenix Electric offers you unlimited options for designing.

- Over 80 years in business
- With hundreds of millions of brush holder assemblies successfully being used in industry and commerce every day, Phoenix Electric brush holders are field-tested, field-proven and have the reputation as the most reliable brush holders in the industry.
- Able to design an infinite variety of brush holders for any application.
- Fast, dependable delivery

Phoenix Electrical Manufacturing

2235 N. Knox Avenue

Chicago, IL 60639

PH: 773-477-8855

Inquiries and Orders: [info@phoenixelectric.com](mailto:info@phoenixelectric.com)



Elec-Tron's only business is giving you the right connections. So their engineers work hard to provide the connections you want, in the space you have, and at competitive prices.

# ELEC-TRON

## *Elec-Tron connectors are in:*

- Ovens, ranges
- Refrigerators
- Freezers
- Microwaves
- Washers, dryers
- Furnaces
- Air conditioners
- Thermostat connections
- Food equipment
- Commercial kitchen equipment
- Vending machines
- Office equipment
- Computers
- Copiers
- Motor controls
- Medical systems equipment
- Material handling equipment
- Automatic door & gate openers
- Recreational vehicles
- Farm machinery
- Marine panels

*and many, many other applications!*

***What is your application?***

perkinspowerproducts.com



### Terminal Blocks

Elec-Tron's molded terminal blocks may be ordered with nearly endless combinations of connectors and terminals along with terminal identification printing, or steel stamped to your specifications.



### Terminal Boards

Standardized spacing, with mounting designs allowing more connections in less space, is the foundation of the most complete line of terminal boards and blocks available anywhere!

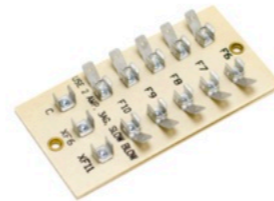

### Fuse panels

Whether your need is for a single terminal or one hundred terminals, quick-connect terminals, screw terminals or solder lugs, Elec-Tron can produce an assembly to exactly match your requirements.

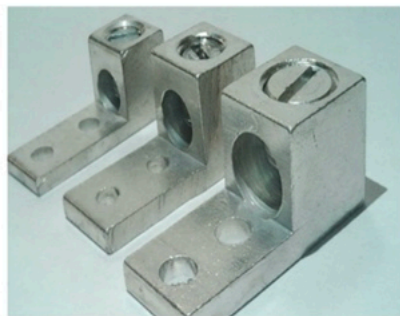

### Connectors

Elec-Tron fabricates mechanical aluminum lug connectors in a variety of designs and to satisfy multiple voltage requirements. These connectors come with an optional installed setscrew.

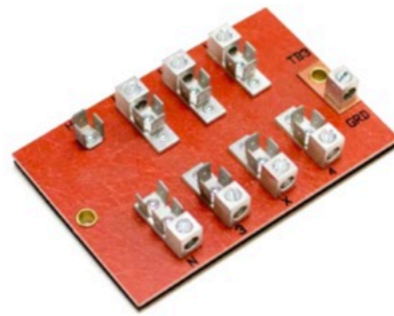

### Terminals

A variety of terminals are available including but not limited to quick connects, screw terminals, and bifurcated soldering terminals. Quick connect tabs are a one-piece construction, single, double, and triple are all available.

### Capabilities

- Compression and injection molding
- Mechanical lug connector manufacturing
- Terminal manufacturing
- Custom terminal board cutting, stamping and printing
- Engineering

**Elec-Tron, Inc.**  
**2050 E. Northern St.**  
**Wichita, KS 67216**

**Phone: (316) 522-3401**  
**Website: [elec-troninc.com](http://elec-troninc.com)**  
**Catalog: [elec-troninc.com/catalog](http://elec-troninc.com/catalog)**

# SABLE PLASTICS GROUP

## A trusted partner for plastic parts

- Thermoset and thermoplastic injection molding capabilities
- Thermoset compression molding capabilities including insert molding
- Design services including part and tooling development
- Their engineering and manufacturing experience has earned them loyal customers for many decades
- Serving customers across many industries including automotive, appliances, HVAC, motors, industrial equipment, transportation, power generation, medical, and military
- Fast delivery

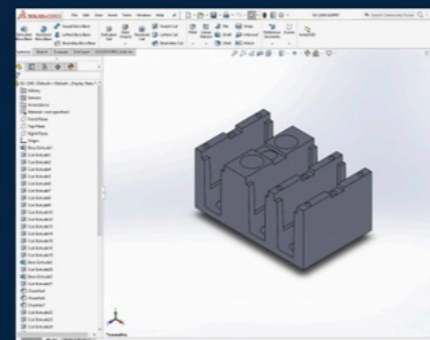

Design Services



Molding Capabilities



Quality Assurance

## Sable Plastics Group

3625 N Halsted St, Chicago, IL 60613

2050 E Northern St, Wichita, KS 67216

Phone: (630) 283-1992

Inquiries and Orders: [sales@sableplasticsgroup.com](mailto:sales@sableplasticsgroup.com)

Website: [sableplasticsgroup.com](http://sableplasticsgroup.com)



# MARTINDALE ELECTRIC CO.

Martindale Electric Co. started in the electric motor maintenance tool manufacturing business in 1913. From the start, they emphasized quality materials and workmanship – and dedicated customer service.

The approach worked. Gradually, they added new products to the line, including commutator treating supplies and specialty abrasives now produced under their roof.

Diamond D by Martindale products are readily available to promptly meet your electric motor repair tool needs. Each and every employee adheres to the standards of product quality and customer service that makes Martindale the one stop shop for electric motor repair tools for more than 100 years.

Martindale Electric Co.  
1375 Hird Avenue  
Cleveland, OH 44107-3008  
Ph: 216-521-8567  
**Website:** [martindaleco.com](http://martindaleco.com)



Diamond D abrasives, a variety of comm stones, garnet paper and more.

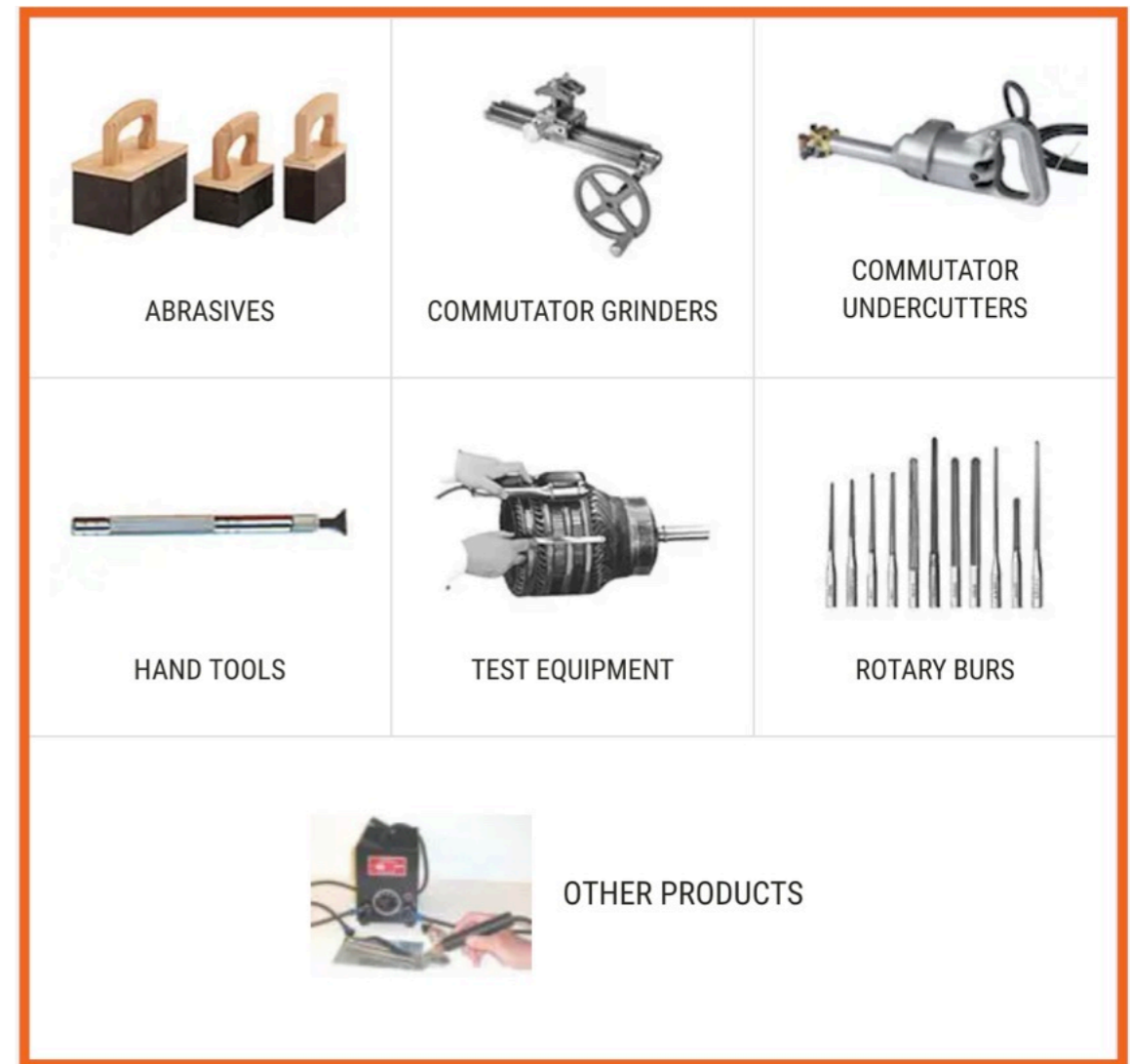

# MARTINDALE ELECTRIC CO.

## RUBRITE FLEXIBLE ABRASIVES

### UNMOUNTED

This type can be used for hundreds of jobs, including metal cleaning, commutator burnishing, and rust removal.

*Specify catalog number when ordering.*

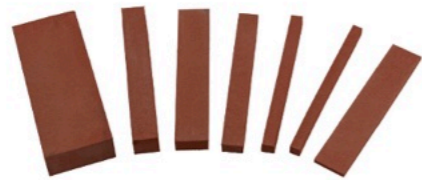

### WITH SAW HANDLE



### WITH FRACTIONAL MOTOR HANDLE



This type is used to clean and polish fractional horsepower motor commutators.

### WITH TRAMWAY HANDLE



*Handle length is 10"*

### WITH POCKET HANDLE



This Rubrite is excellent for burnishing small motor and generator commutators.

*Specify catalog number when ordering.*

### WITH RAILWAY HANDLE



This handle is mounted vertically, which gives excellent leverage.

*Specify catalog number when ordering.*

Rubrite flexible abrasive cleaning stones are excellent for removing surface imperfections from any metal. Mildly abrasive, they do only enough cutting to produce a high polish and fine finish. They are slow-wearing, non-loading, and will not gum or dust. Recommended in commutator maintenance for periodic cleanup of surface, or for polishing the commutator after grinding with Diamond D commstones.



# VAHLE, INC.



Vahle USA

## Mobile Electrification & Automation Systems

VAHLE USA delivers reliable mobile electrification, power, data and control solutions engineered for cranes, intra-logistics, ports, automotive and amusement applications across North America.

Established in 1973 in Katy, Texas, VAHLE Inc. serves as the North American headquarters for the VAHLE Group. They provide engineered solutions, proven products, and full-service installation and maintenance across the United States, Canada and Mexico, supporting industries such as crane technology, intra-logistics, ports, automotive and amusement parks.



**Conductor systems**

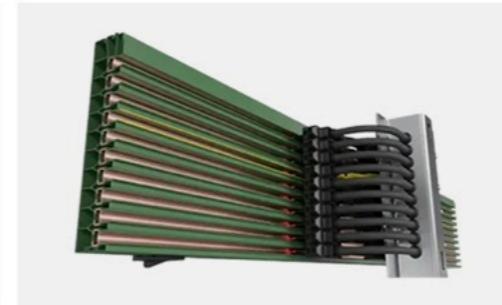

**Compact conductor systems**



**Enclosed conductor systems**



**Festoon systems**



**Cable reels**



**Contactless power supply**

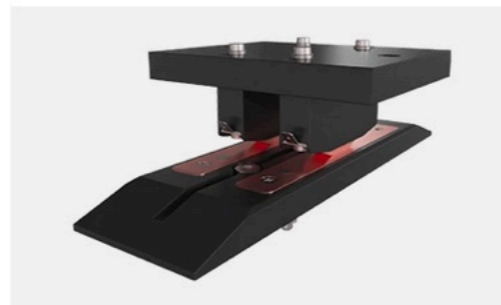

**Charging contacts**

**VAHLE Inc.**  
**407 Cane Island Parkway**  
**Katy, Texas 77494**  
**USA**  
**sales.usa@vahle.com**  
**+1 713 465 9796**



# PERKINS RESOURCES

Supplying obsolete and hard to find electrical and mechanical parts since 1947.



- Repair and supply replacement contacts and contact kits, all manufacturers
- Magnetic/Drum Controller, electrical and mechanical, all manufacturers
- Crane Parts: trolley wheels, cast iron slide shoes, complete assemblies of current collectors utilizing wheels & shoes, pantographs, insulators, graphite paste, copper shunts, electrical parts, brake shoes, brake parts, bumpers, complete brakes
- Brushholders: new, replacement, and re-design

# PERKINS POWER PRODUCTS, LLC

Service with a Sense of Humor

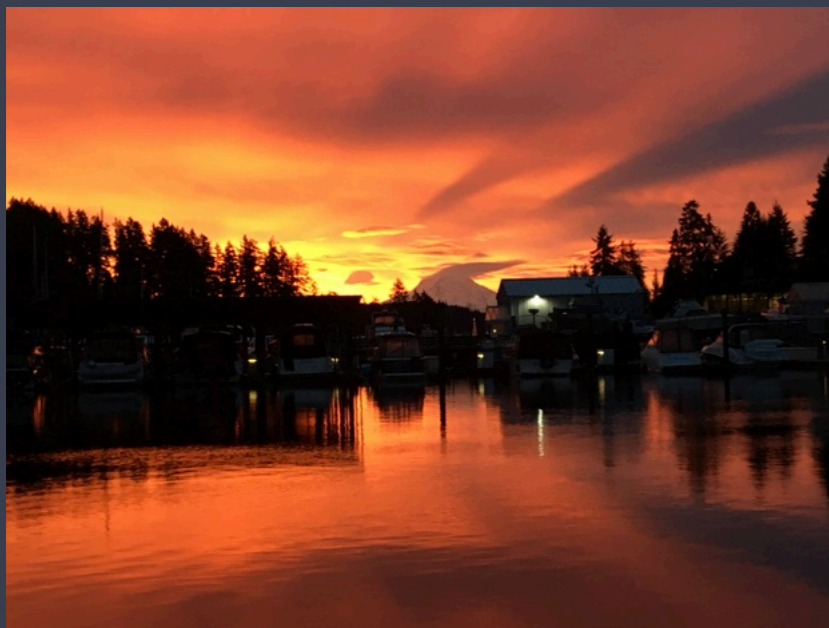

## Manufacturers Representatives

Since 1947 the Perkins Family has been supplying the Pacific Northwest, Alaska, and British Columbia, Canada, with industrial motor and control parts, power distribution and insulation, and crane control and electrification.

### Contact us:

Daniel and Tracy Perkins

Perkins Power Products, LLC

4216 31st Avenue Ct

Gig Harbor, WA 98335

Phone: 253-853-7456

Daniel: [daniel.perkins@perkinspowerproducts.com](mailto:daniel.perkins@perkinspowerproducts.com)

Tracy: [tracy.perkins@perkinspowerproducts.com](mailto:tracy.perkins@perkinspowerproducts.com)

[www.perkinspowerproducts.com](http://www.perkinspowerproducts.com)

